



da Vinci 1.0 User Manual

This manual provides detailed instructions on how to use your new da Vinci 1.0 3D Printer. The instructions are for your safety and to properly maintain your printer. Visit our website <http://www.xyzprinting.com> or contact your sales representative to get the latest available information on your da Vinci 1.0 3D Printer.

Doc Edition	Month	Year
1.5	July	2014

CONTENT

Chapter 1 Important Safety Instruction	4
Chapter 2 Overview	6
Chapter 3 Installing and Set Up	8
Chapter 4 Connect the Cable	9
Chapter 5 Load the Filament	10
Chapter 6 Printer Functions	12
6-1 UTILITIES	13
6-1.1 LOAD FILAMENT.....	14
UNLOAD FILAMENT	15
6-1.2 HOME AXES.....	16
6-1.3 JOG MODE.....	17
6-1.4 BUILD SAMPLE.....	18
6-2 SETTINGS	19
6-3 INFO.....	19
6-3.1 STATISTICS.....	20
6-3.2 SYSTEM VERSION.....	20
6-3.3 CARTRIDGE STATS.....	20
6-4 MONITOR MODE.....	21
6-5 Print Bed Adjustment.....	22
Chapter 7 Q&A	23
Chapter 8 Term of Service	27

Chapter 1 Important Safety Instruction

Please read this manual carefully before operating the printer. The following warnings and attention notices are a best effort attempt to cover all scenarios; unfortunately it is not possible to do so. In the case of performing maintenance procedures that are not described in this manual the burden of safety falls to the customer side.

For basic safety and precautions adhere to the following:

Warning

- Do not let children operate this device without adult supervision. Electric shock hazard. Moving parts can cause serious injury.
- Do not place the printer on an unbalanced or unstable surface. Printer may fall or tumble causing harm and/or injury. Printer may fall or tumble causing harm and/or injury.
- Do not place any objects on top of the printer. Liquids and objects that fall into the printer can lead to printer damage or safety risks.
- Do not use flammable chemicals or alcohol wipes to clean this device.
- Do not disassemble or replace the printer cover with non-XYZprinting covers.
- Do not touch heated surfaces during or after operation. Heated surfaces can cause severe burns.
- Insert and secure the power cord firmly for proper usage and to avoid potential electricity and fire dangers.
- Do not attempt to service the printer beyond the instructions specified in this document. In the case of irrecoverable problem, contact XYZprinting service center or your sales representative.

Attention

- Please place and use the printer in a well ventilated area. The process of heating the filament will produce a small amount of non-toxic odor. Having a well ventilated area will ensure a more comfortable environment.
- This printer is only to be used with filament specified by XYZprinting.
- Make sure to set the power switch to the off position and remove the power cord before transporting the device.
- Some components of the printer are moving during operation. Do not attempt to touch or change anything inside before power off the printer.

ENG

Important Notice

Please follow these instructions before using this device.

1 Remove print bed fixing screw and module fixers. (packing supports x2, tapes x2, cable tie x1) Damage can occur if the device is powered up and fastener are not removed.

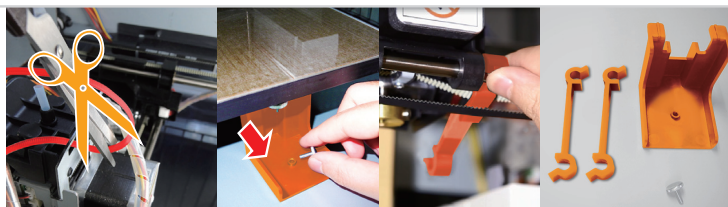

2 Remove the filament cartridge locker to make way for the filament cartridge. Place the filament in the printer and insert the filament cartridge locker. Push the click locker in the slot.



3 **Do not recalibrate the print bed.** This product was calibrated before being shipped from the factory and improper adjustment will impact print quality. If the print object looks like the one on the right, refer to "Print Bed Adjustment" contact service personnel before continuing operations.

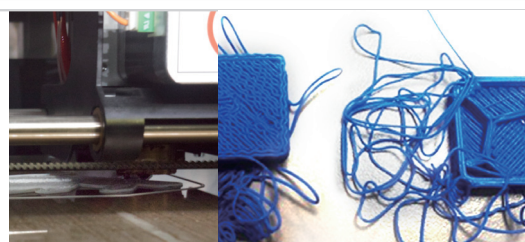

4 Connect a PC to the printer using a USB cable. After connection, start XYZware. Following the proper operating procedure improves print quality.



5 If the PC is running on MAC OS or Windows 8/8.1, refer the official XYZprinting website to learn about the proper installation method and download the latest software. Visit <http://support.xyzprinting.com/doesloads> for detailed support information.

6 It is highly recommended that users make use of the XYZware to register their products online when using it for the first time. Registering your printer on line brings the latest technical and support information directly to you. Refer to the screen to the right.

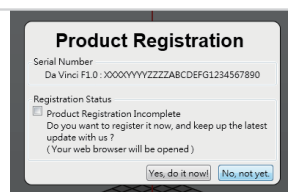

7 For better print results; before pressing "print" on the XYZware preview; apply a thin coating of the supplied glue stick on the print bed. The thin coat should only cover the estimated area of the objects print size. After printing and removing the object, wipe the print bed clean with a damp cloth.

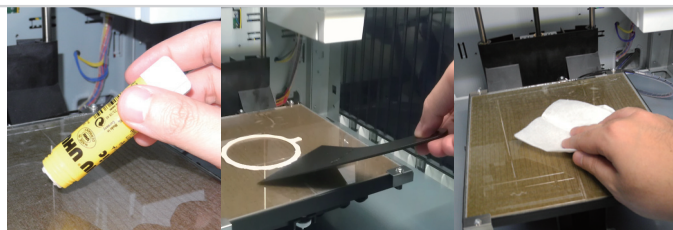

8 Optimal room temperature for printing is 15-32 °C (60-90 °F) If temperature is higher or lower it may impact print quality.

9 Additional support and resources are available by visiting our website <http://support.xyzprinting.com>

Chapter 2 Overview

This chapter describes the unpacking and set up of the printer. Before proceeding to this chapter, please make sure read the Chapter 1. Important Safety Instruction is acknowledged carefully.

Open the box



Note: Cable tie illustrated in step 4 in this section is used to fix the extruder during transportation. It should be removed before powering on the printer, or the printer may not function normally.

- 1 Open the box and remove the accessories and the cushion.
- 2 Take out the printer by holding the side handles.
- 3 Remove plastic bag and tapes.
- 4 Open the top cover, then remove packaging supports and tapes from inside.
- 5 Remove the cardboard.
- 6 Remove the print bed shipping tapes and foam cushioning pieces.
- 7 Remove the bottom screw and the plastic piece under print bed.
- 8 Remove the drip tray packaging tapes.
- 9 Use the USB cable to connect the printer to PC. Connect the power cord to the printer then turn on the power switch.



Attention

- Retain the box and packing material. If the need arises, it will be used to transport the unit.
- This device without packing material or box is weighted around 23Kg (50lb). Handle the printer carefully to prevent personal injury and damage of the printer.

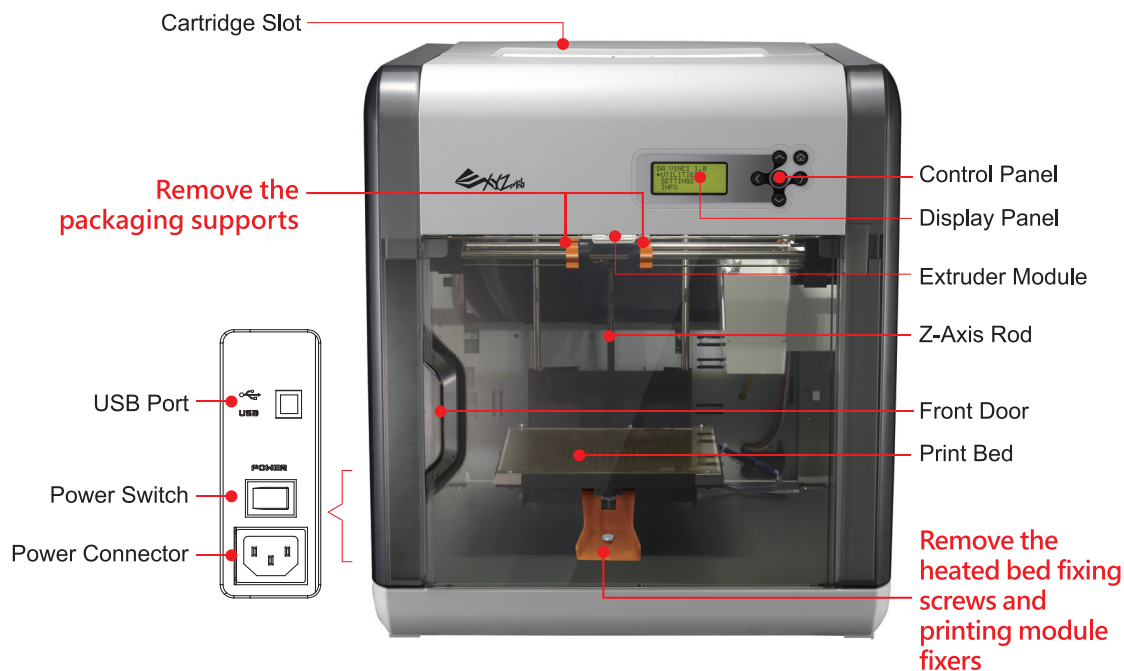

- Display Panel: information on printer status.
- Key Pad: use to operate functions in the printer.
- Extruder Module: to be used for printing 3D objects.
- Z-Axis Rod: to be used to provide print-enabled lifting heated bed module.
- Access Door: to be used for operating or maintenance.
- Print bed: provides a flat surface to lay the 3D model.
- Cartridge Slot: space for placing the filament cartridge.
- USB Port: used for connecting the USB cable.
- Power switch: this switch turns on/off the power of the printer.
- Power Connector: to be used to connect the power cord.

Attention

Once the 3D printer is turned off, wait at least 3 seconds before turning it on again.

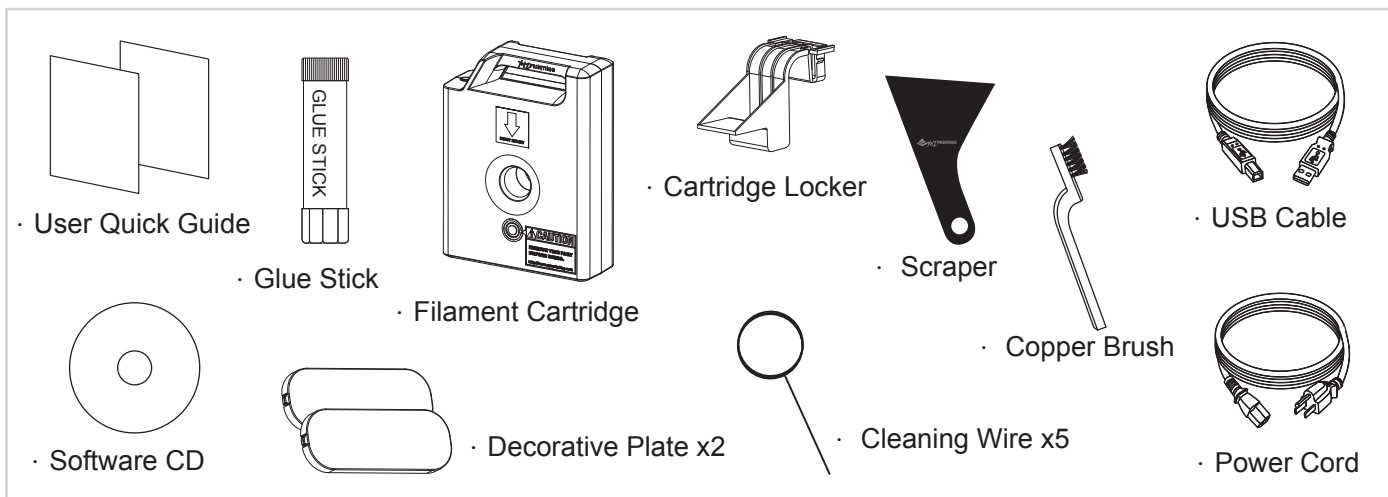

Chapter 3 Install and Set Up

Parts name and functions

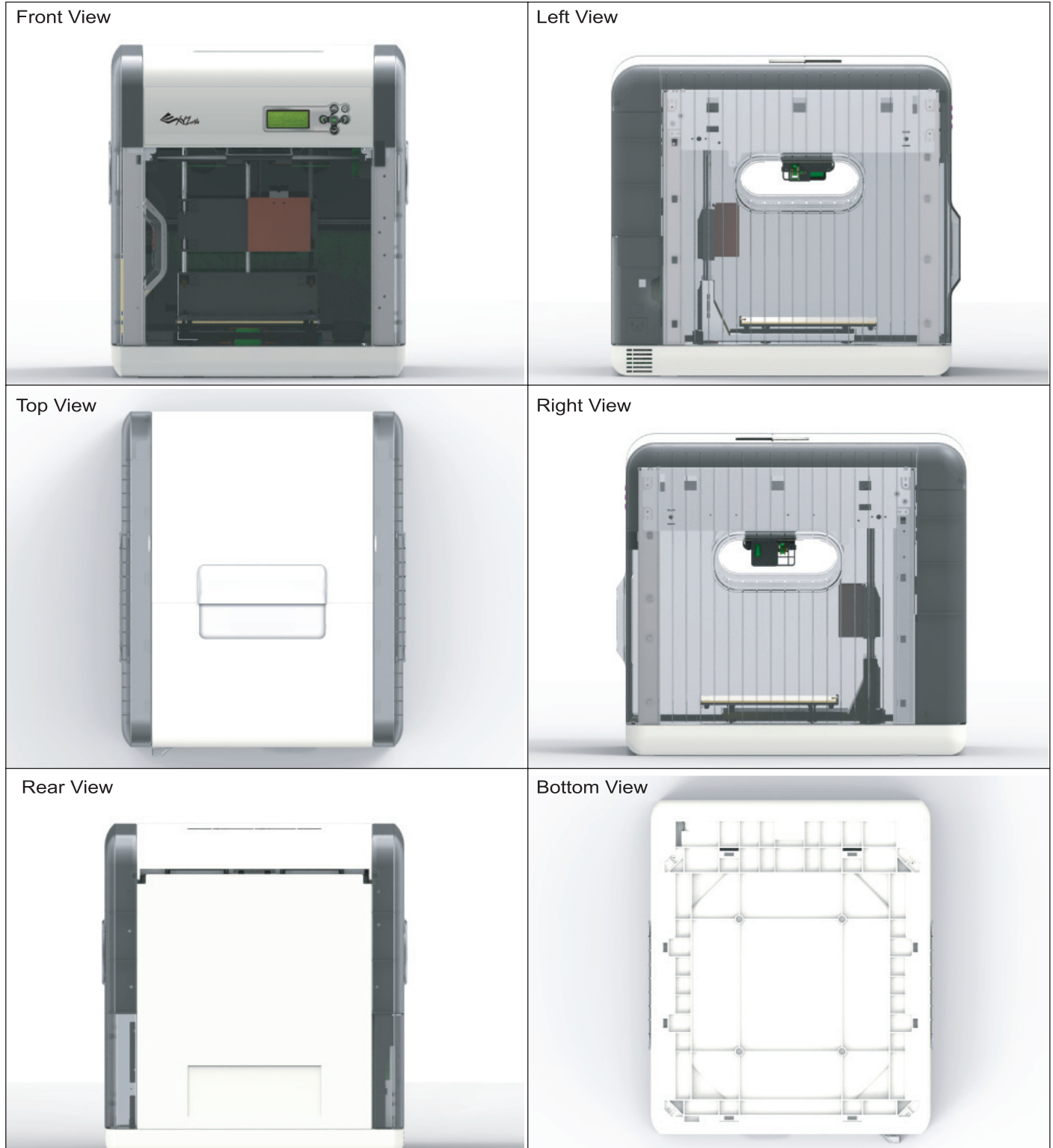

Chapter 4 Connect the Cable

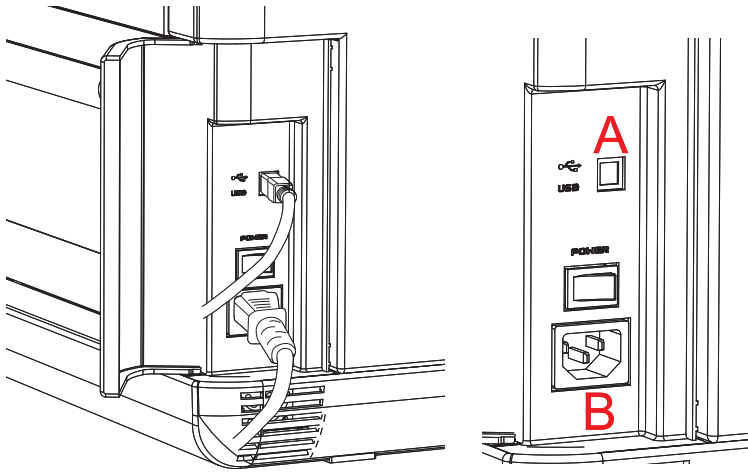

<A. USB Port / B. Power Outlet>

Warning

- Make sure to set the power switch to the “off ” position before inserting the power cord.
- Make sure the power cord is properly connected. Incorrect use may cause damage to the printer.
- Make sure to remove the power cord from printer if you are storing or not using the printer for an extended period of time.
- Make sure to avoid power strips to power the printer . Use a wall outlet.

Connect USB Cable and Power Cord

Connect the printer power cord and USB cable to the back of the printer.

Power On the Printer

Please switch the power button to “I” icon ,the information of printer will be shown on the panel, it is ready to print.



Chapter 5 Load the Filament

Install Cartridge

- 1 Remove filament stopper and tape.
- 2 Install the new filament cartridge into the empty slot.
- 3 Place and push to click the cartridge locker into the slot.
- 4 Push the filament through the filament guide tube to the hole of the extruder and press "LOAD FILAMENT" function on the display menu.

Note: Before pushing the filament into the guide tube, it is advised to cut the tip of the filament off at a 45° angle with a cutting pliers, filament loading will be easier.

Tips: Grasping the release arms while inserting, it will make it easier to push filament into the extruder.

Load filament

- 1 Choose "UTILITIES" and press "OK" to continue.
- 2 Choose "CHANGE CART" and press "OK".
- 3 Choose "LOAD FILAMENT" and press "OK".
- 4 Please wait for extruder to reach working temperature.
- 5 Please wait for completion of filament loading.
- 6 Check if the nozzle outputs filament and press "OK" to go back to main menu.

Sample print

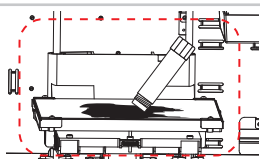

Apply glue to print bed before printing. Glued area depends on the measurement of the object(s) to be printed.

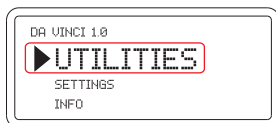

1 Choose "UTILITIES" and press "OK" to continue.

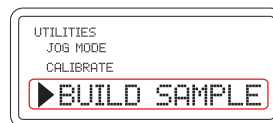

2 Choose "BUILD SAMPLE" and press "OK" to continue.

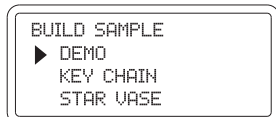

3 Select one of the samples.

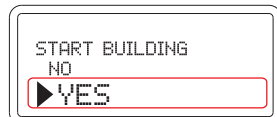

4 Select "YES" and press "OK" to start printing.

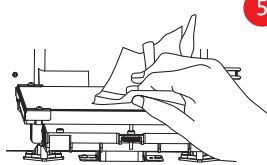

5 Remove the printed object when the print bed has descended. Cover a damp cloth on the print bed (while cold) for 2~3 minutes. Then wipe the moistened glue from the print bed with the damp cloth gently.

Unload filament

Note: To avoid clogging the extruder, complete the "UNLOAD FILAMENT" procedure before changing the cartridge. Do not cut filament from the extruder.

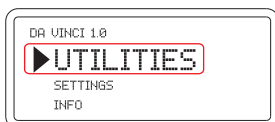

1 Choose "UTILITIES" and press "OK" to continue.

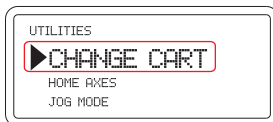

2 Choose "CHANGE CART" and press "OK".

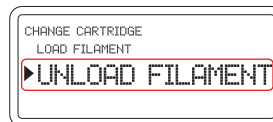

3 Choose "UNLOAD FILAMENT" and press "OK".

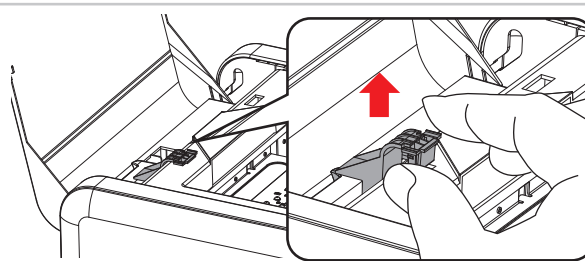
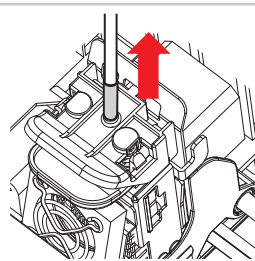
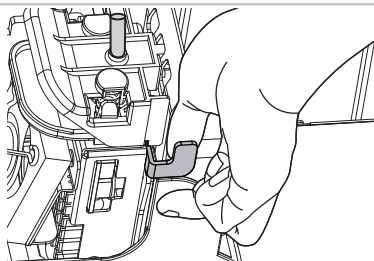

3 Remove filament slowly when printer has reached working temperature as instructed. Then remove cartridge locker and the cartridge unloaded.









Attention

Shipping notice:

- Please unload the filament before printer shipping.
- Please use the regular carton and protection material.
- Do not put the printer in the carton while extruder or heated bed still warm and make sure both are completely cool down before packing.

Chapter 6 Printer Functions

Functions of Control Panel Key on the printer:

Button	Functions
	Direction Up
	Direction Down
	Back to pervious menu
	Forward to submenu
	OK; confirm selection/settings
	Home Button, return to main menu

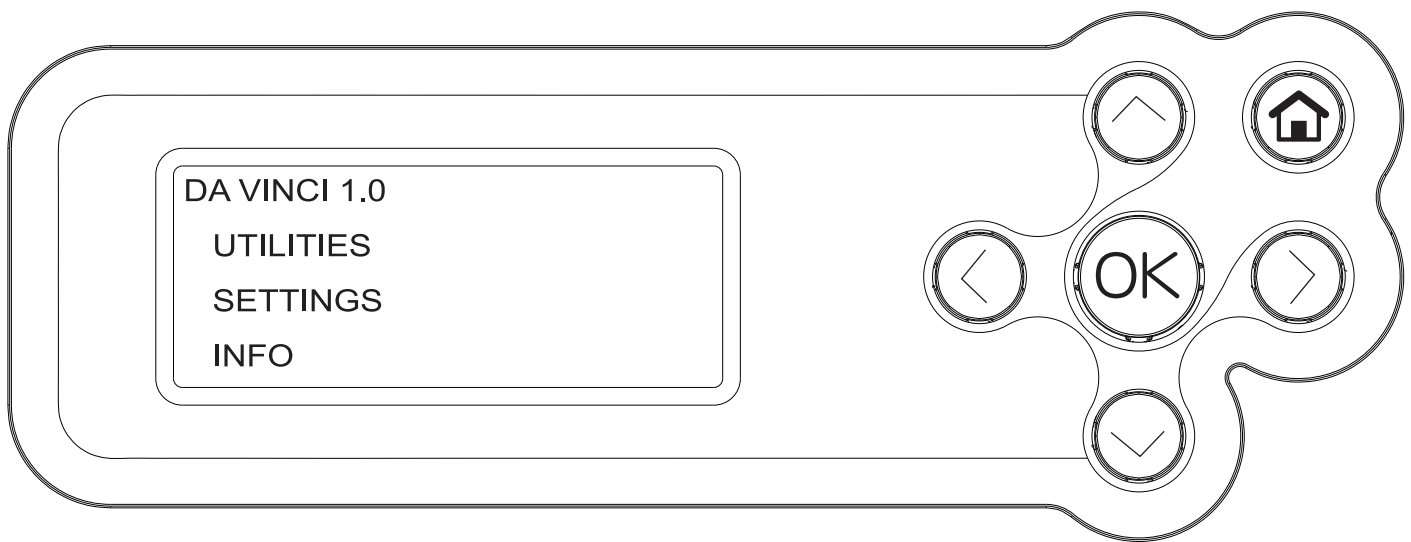

Function	Description
UTILITIES	Printer adjustment / Change filament / Sample printing
SETTINGS	The parameters of printer
INFO	The firmware and printer statistical information
MONITOR MODE	Monitor of extruder and heated bed working temperature and printing progress

6-1 UTILITIES

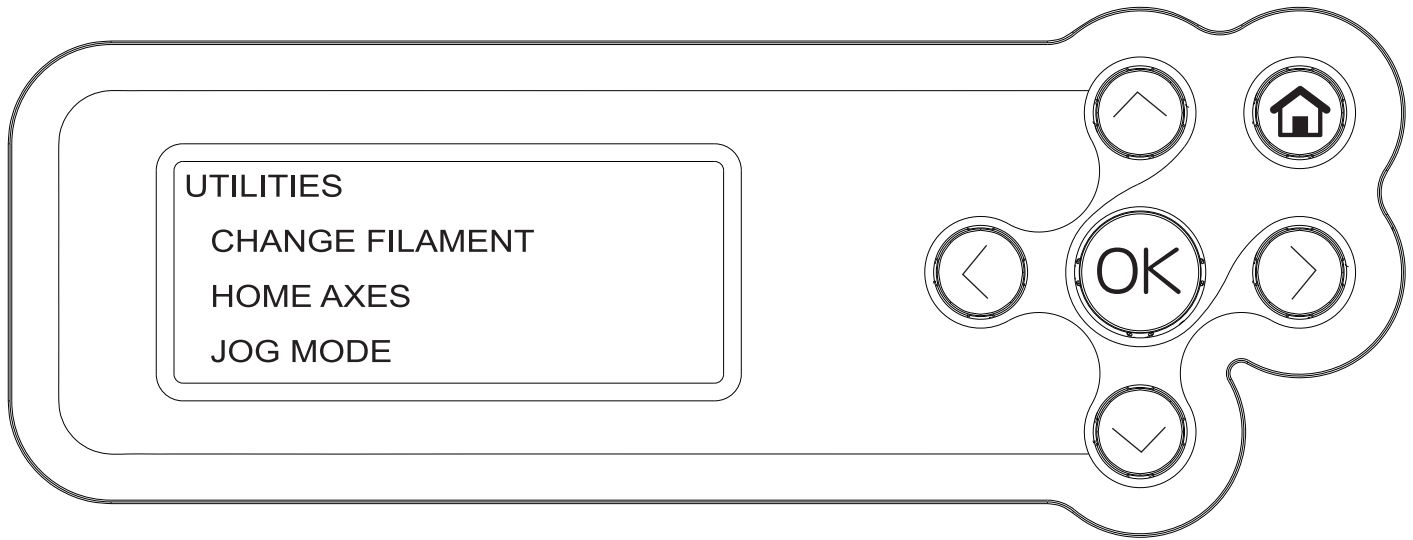

Function	Description
CHANGE CARTRIDGE	Loads/unloads filament
HOME AXES	Moves the extruders and print bed to default "home" location
JOG MODE	Manually adjusts the movement of X/Y/Z Axis for printer maintenance
BUILD SAMPLE	Prints sample build
CLEAN NOZZLE	Heat the extruder and move it to the center for manual cleaning
CLEAN DRIPBOX	Move the extruder to the center for manual dripbox cleaning

6-1.1 LOAD FILAMENT

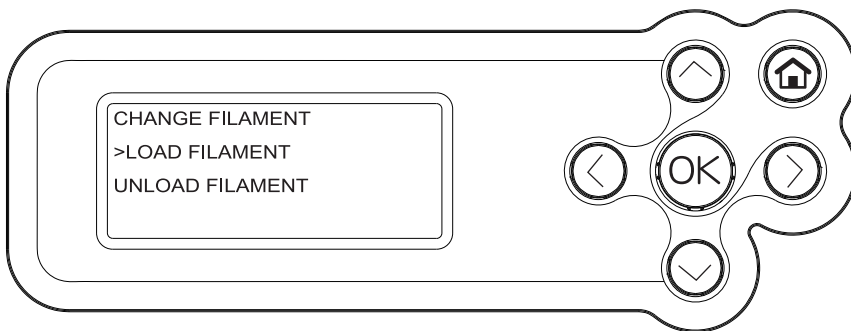

1. Choose "CHANGE FILAMENT" > "LOAD FILAMENT".

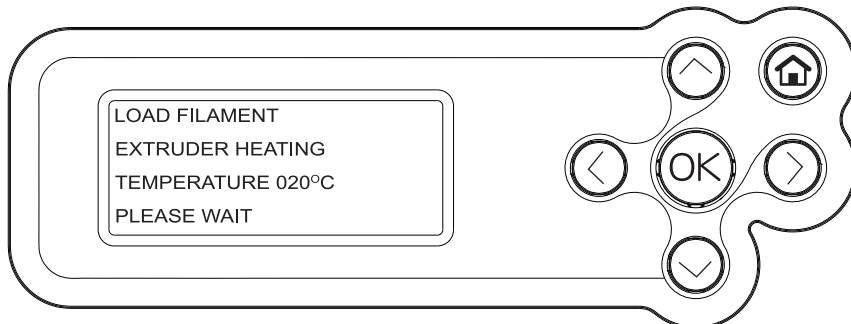

2. Please wait for extruder to reach working temperature.

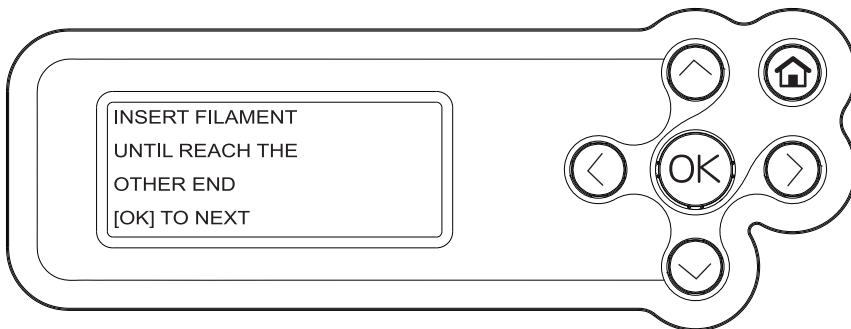

3. Push the filament through the filament guide tube to the hole of the extruder and press "OK" button.

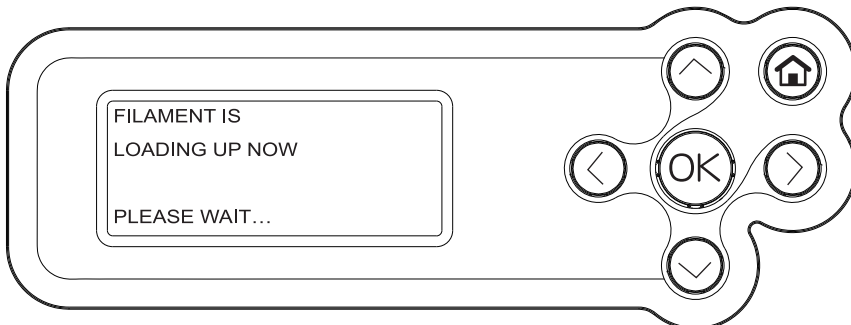
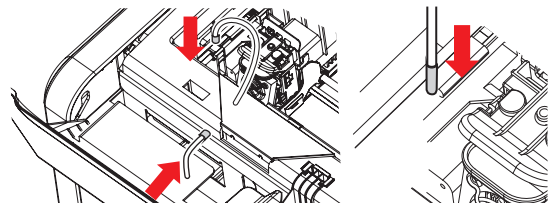

4. Please follow instructions on the panel and press "OK" to finish this process; it is normal if filament color comes out not you expected in the beginning. Some filament left over inside the extruder from last printing.

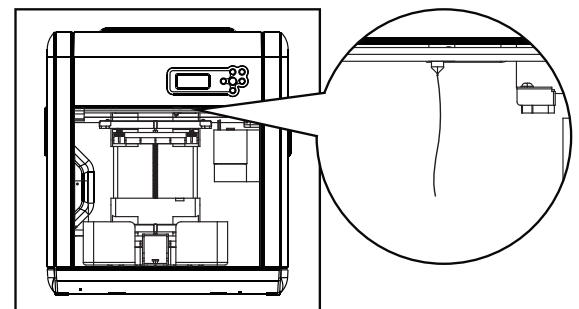
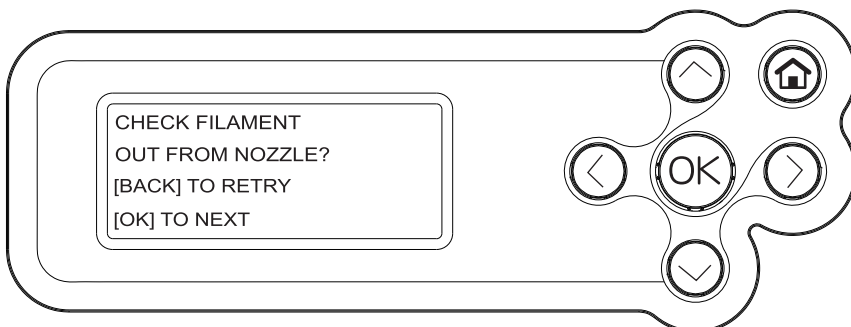

6-1.2 UNLOAD FILAMENT

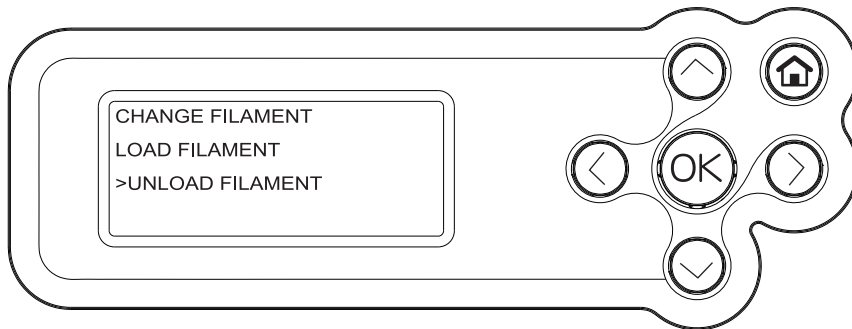

1. Choose “CHANGE FILAMENT” > “UNLOAD FILAMENT”.

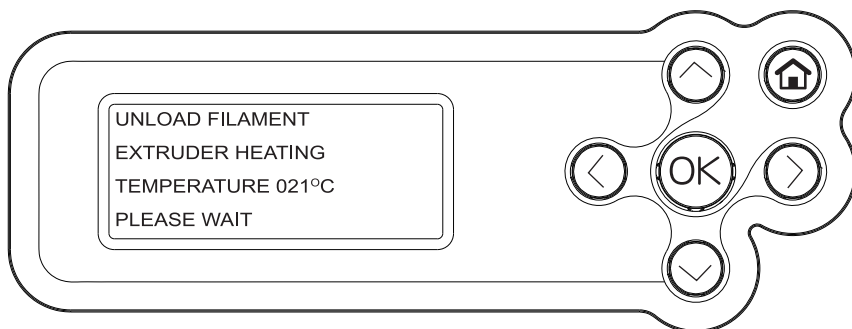

2. Please wait for extruder to reach working temperature.

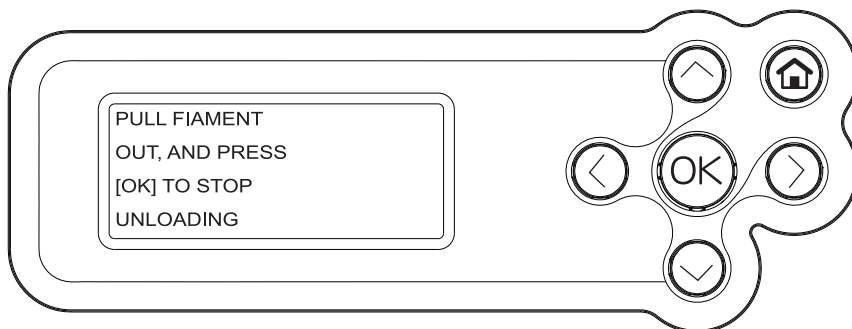

3. Pull the filament through the filament guide tube to the hole of the extruder and press “OK” button.

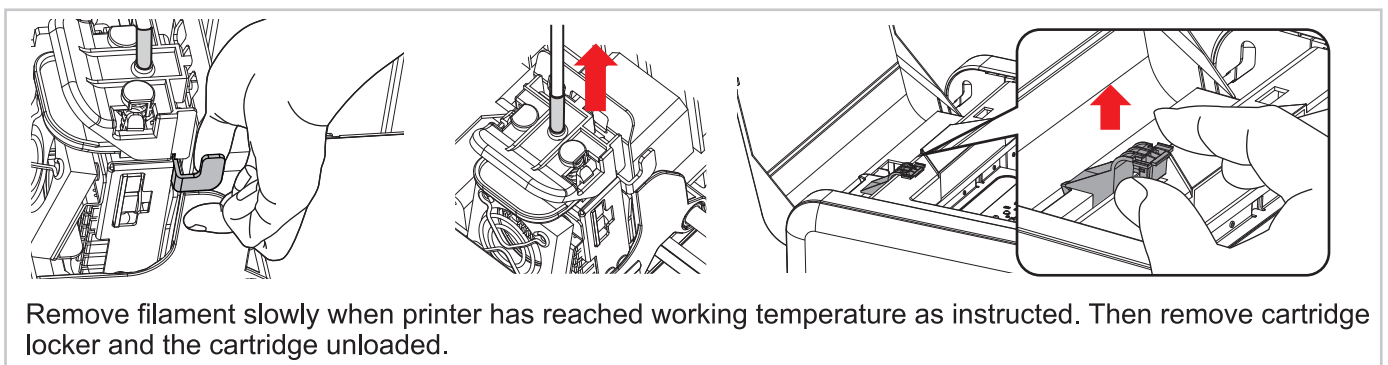

Remove filament slowly when printer has reached working temperature as instructed. Then remove cartridge locker and the cartridge unloaded.

6-1.3 HOME AXES

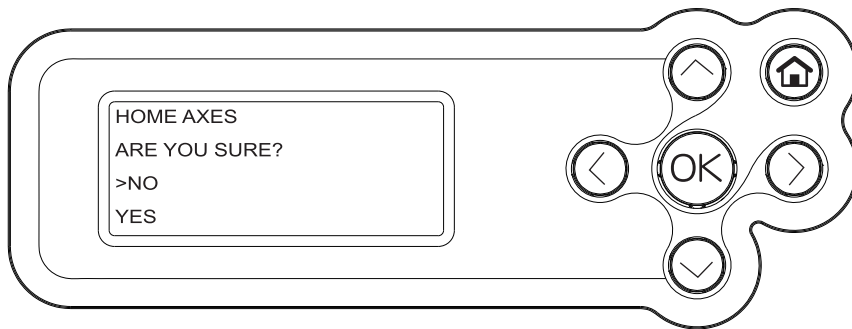

1. Choose the HOME AXES function and press “Yes”, extruder and heated bed will move to proper positions.

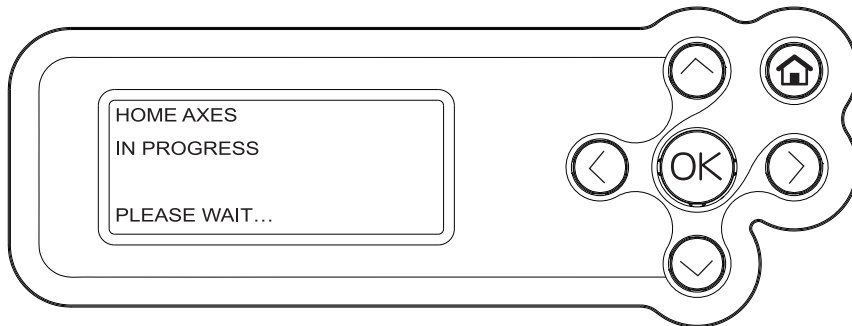

2. Wait for extruder and heated bed moving process finish.

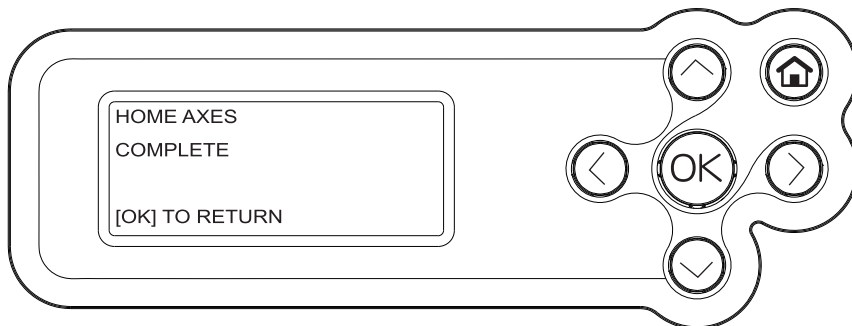

3. Refer the information from display panel, process complete message will be shown, press “OK” to return main screen.

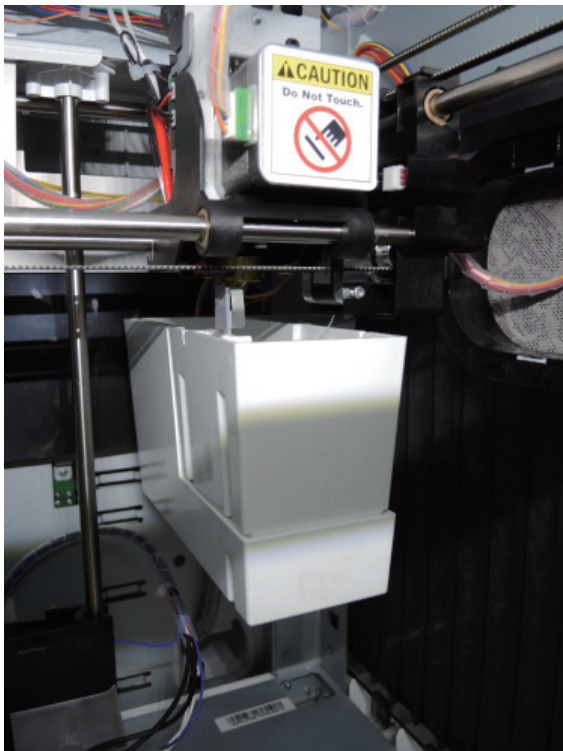

6-1.4 JOG MODE

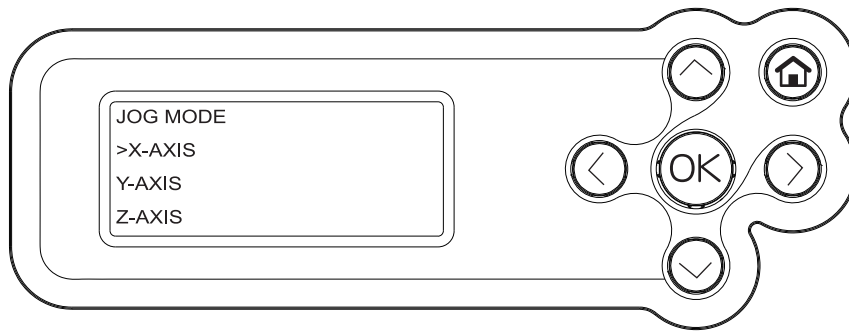

1. Choose the proper axis and press "OK" to next steps.

Options:

X AXIS / Y AXIS / Z AXIS

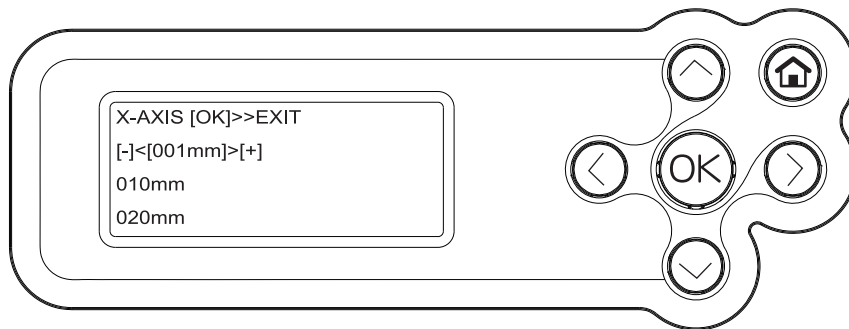

2. Select adjustment degree

- Use Upper / Down button to switch adjustment degree.

- Use Left / Right Button to apply a default scale.



6-1.5 BUILD SAMPLE

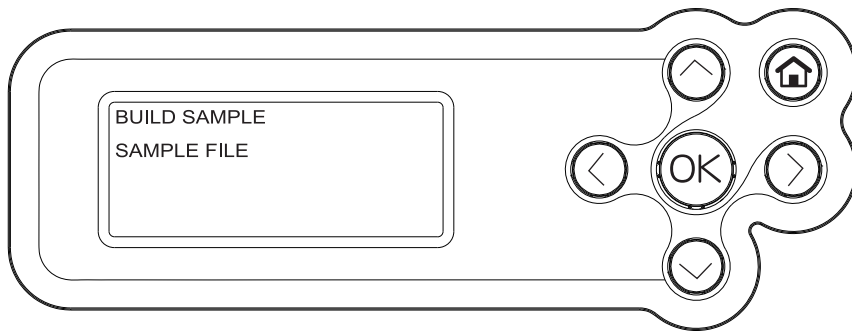

1. Choose printing sample.

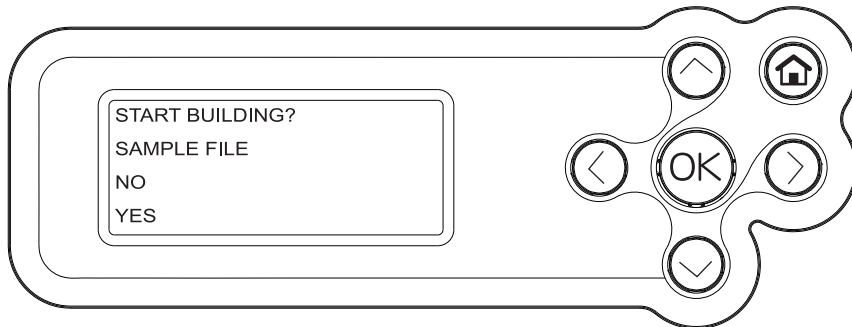

2. Press "OK", printer will be start to print.

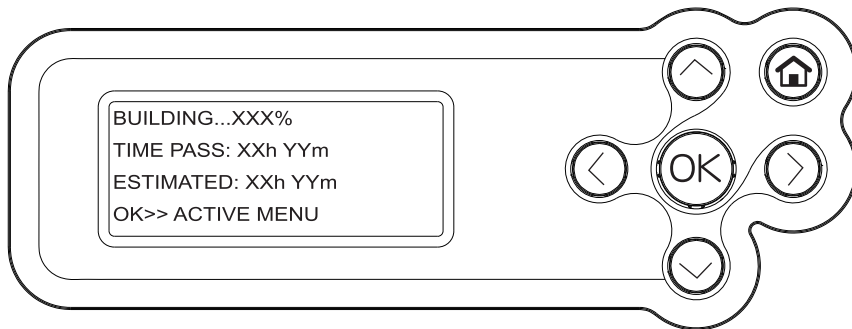

3. Printing status will be refresh on the LCD panel

- BUILDING : the percetenge of printing finish.
- TIME PASS : elapsed build time.
- ESTIMATED : estimation of build time.

6-2 SETTINGS

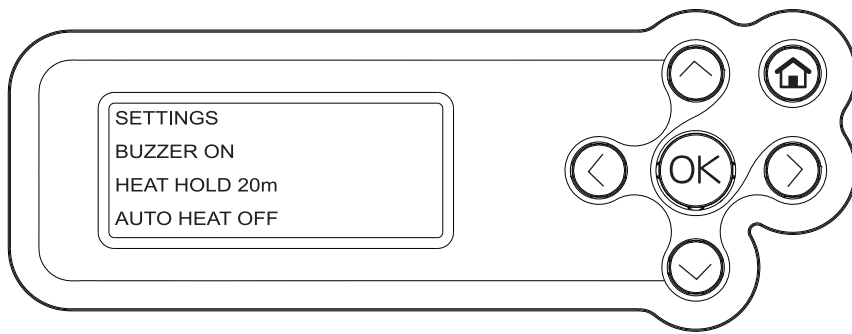

Function	Directions	Default
BUZZER	Buzzer for alerting	On
AUTO HEAT	Keep the extruders and print bed at working temperature when printer is powered on	Off
LANGUAGE	Set the language displayed on the panel. Available options: English & Japanese	English
RESTORE DEFAULT	Apply default settings	

6-3 INFO

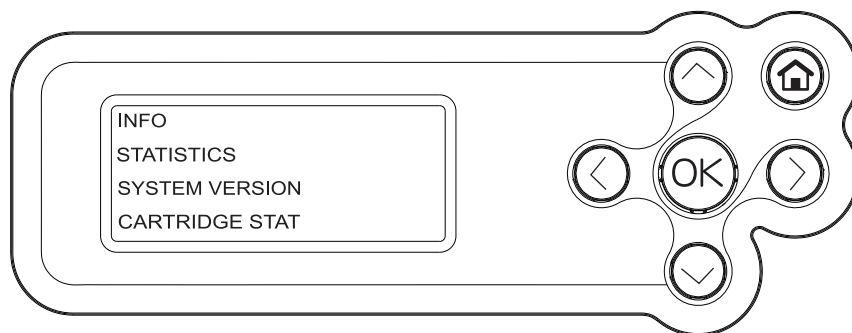

Function	Directions
STATISTICS	Used time of printer
SYSTEM VERSION	Version of firmware
CARTRIDGE STATS	Capacity, remaining of filament

6-3.1 STATISTICS

- LIFETIME : Amount printing time of the printer
- LAST TIME : Printing time of last task in this printer

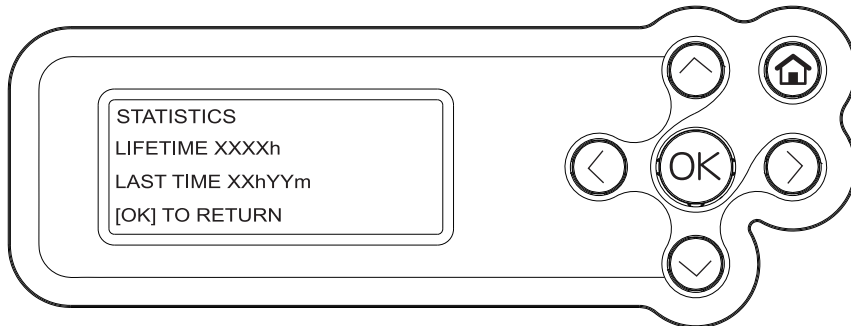

6-3.2 SYSTEM VERSION

Printer version information will be shown on the display panel

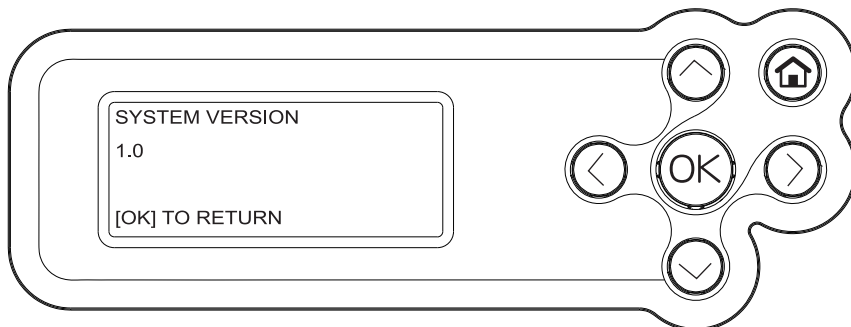

6-3.3 CARTRIDGE STAT

Some information related to filament which in the printer will be shown as below:

- REMAINING : remaining length of filament
- CAPACITY : original length of filament

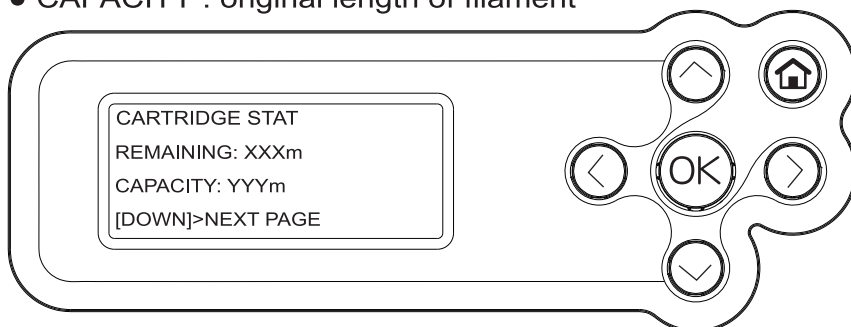

6-4 MONITOR MODE

You can get the temperatures of information via Monitor Mode function

- EXTRUDER : Proper working temperatures is 210 °F / 410 °F
- PLATFORM : Proper working temperatures is 90 °F / 194 °F

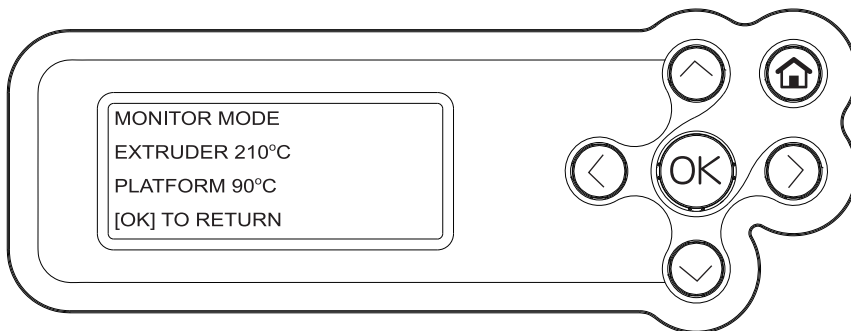

6-5 Print Bed Adjustment



This print bed has been factory calibrated before shipping. Recalibration is necessary if there are print issues when starting to print or the nozzle gets too close to the print bed. When in doubt, it is recommended to contact service center for more information.

Print bed adjustment flow chart

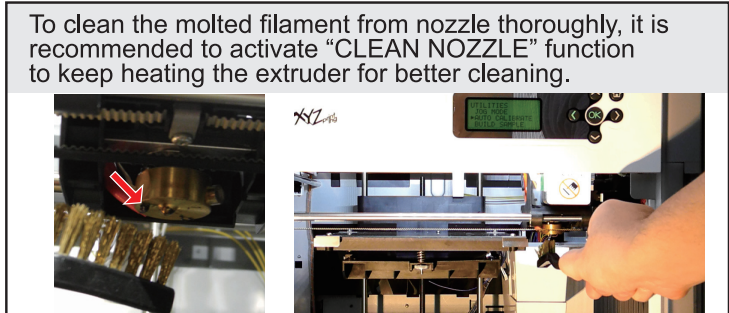
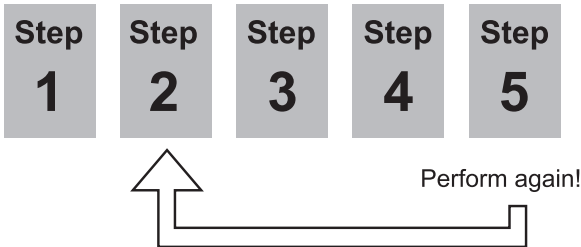

To clean the molted filament from nozzle thoroughly, it is recommended to activate "CLEAN NOZZLE" function to keep heating the extruder for better cleaning.

Print bed adjustment steps

- Click "INFO>SYSTEM VERSION" using the function keys to make sure your firmware is the latest.

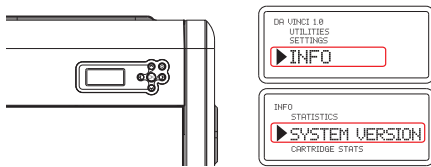

- Click "UTILITIES>CALIBRATE" using the function keys and select "Yes" to perform calibration.

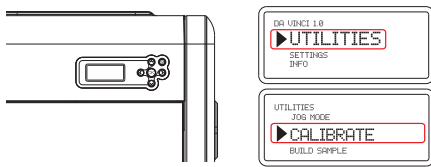

- The printer starts automatic measurement. Wait for 2~3 minutes and verify the data shown.

Note: During the measurement process, the print bed and print module will be heated. Care should be taken during operation!

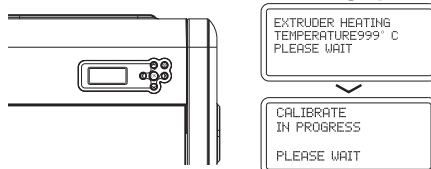

- If **SUCCESS** is shown,

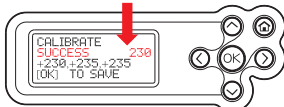

→The printer does not need adjustment and press **OK** to exit.

- If **FAIL** is shown,

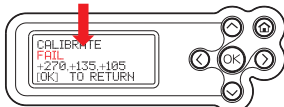

→The printer needs adjustment, refer to the values shown. If the 3 values are more than +/- 20 from each other, this will result in a "FAIL" calibration.

- Refer to the values for adjustment:
Step-by-step adjustment

- Adjust the screw at Point A to reduce the difference between the 1st and the 2nd measurements.
- Adjust the screw at Point B based on your evaluation of the results obtained from the previous steps.
- Finally, adjust the screw at Point C to reduce the difference between all measurements

Note:

* Please adjust the values to between 200~250

* 3 values should be no more than +/- 20 from each other.

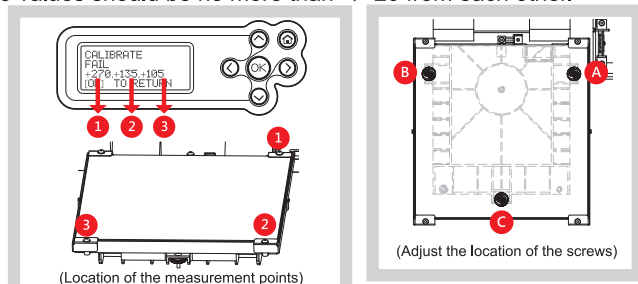

View the printer from the front when making adjustment

Rotate the screw to the left to **raise the bed (value increases)**
Rotate the screw to the right to **lower the bed (value decreases)**

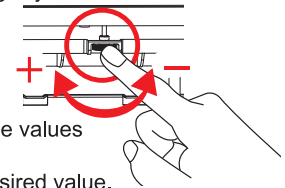

Each full turn leads to a change of 50 to the values shown.

Use small dial turns to approximate the desired value.

- After the adjustment is finished, perform step 2. Wait until **SUCCESS** is shown and press **OK** to complete calibration.

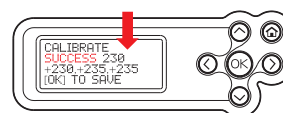

✘ Reminder

If the value shown is always **ERR,ERR,ERR**, follow the steps below to clean.

- Clean the surface of the print head using the copper brush. (Clean the contact point between the print head and print bed)
- Wipe and clean the measurement points as shown in step 4.
- Perform the calibration process again.

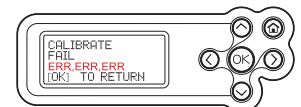

Chapter 7 Q&A

Q1. Are there any suitable applications or software for this printer?

A1. The packaged CD contains the XYZWare software. After installation it will use an available internet connection and look for the latest release to perform an automatic update.

For further information and instruction of the service code, please refer to :
<http://support.xyzprinting.com/manuals>

Service Code	Display Panel Description
0010	Extruder or heated bed higher/lower than maximum/minimum temperature during printing
0011	Extruder or heated bed cannot heat to the specified temperature
0013	The temperature of heated bed reach to warning range limited
0014	The temperature of extruder reach to warning range limited
0030	X axis motor failed results moving failed or X axis home sensor failed results home detect failed
0031	Y axis motor failed results moving failed or Y axis home sensor failed results home detect failed
0032	Z axis motor failed results moving failed or Z axis home sensor failed results home detect failed
0040	Memory storage cannot read/write
0050	Flashrom cannot read/write

Important Safety Instruction



The maintenance tools provided should only be handled by an adult. Please keep the tools away from children. Incorrect handling or maintenance of the printer may cause damage to the product or personal injury.

Information and usage of the advanced maintenance tools

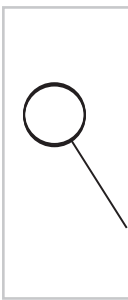
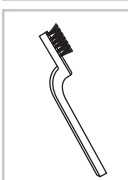

	<p>■ Scraper Scraper is used to remove printed object from print bed when printing is completed. (Caution: do not remove the printed object while the print bed is hot.)</p>
	<p>■ Cleaning Wire Cleaning wire is used to remove the filament left in the path inside the clogged nozzle. (Caution: Print bed may be hot during cleaning, please keep away from the platform to avoid personal injury.) When cleaning the printer nozzle, gears or filament path please ensure to keep hands clear of the print bed which may be hot.</p>
	<p>■ Copper Brush Copper brush is used to clean and remove molten filament left on the tip or surface of the extruder and inside the drive gear. When the printer fails to calibrate consistently; clean and remove the filament form extruder(s) surface.</p>

Specifications

FEATURES	da Vinci 1.0 3D Printer	FEATURES	da Vinci 1.0 3D Printer
Print Technology	Fused Filament Fabrication(FFF)	Nozzle Diameter	0.4 mm
Printer Head	Single Head	AC Input	100-240V, 50~60Hz
Build Volume(W x D x H)	20 x 20 x 20 cm	Connectivity	USB 2.0 x 1
Layer Resolution Settings	Standard 200 microns	Display	FSTN LCM (16 Characters x 4)
	Speed 300 microns	Control Method	Key x 6
	Ultra fast 400 microns	Indicator	Buzzer
	Custom 100-400microns	Lighting	LED
Filament Diameter	1.75 mm	Weight	26 Kg

This section describes how to properly clean the printer under the following conditions:

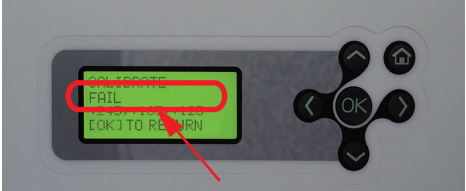
A. Fail to calibrate or printed object is polluted by different color filament

 <p>I. Printer calibration failed constantly</p>	 <p>II. Printed object is polluted by different color filament</p>
---	--

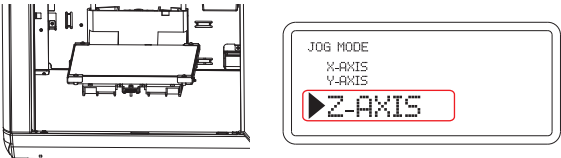
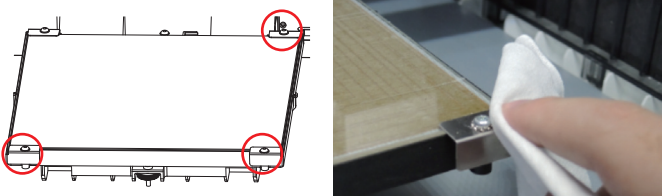
 <p>1 Make sure the heated bed has been moved to the appropriate location, or use JOG MODE feature to adjust Z-AXIS.</p>	 <p>2 Clean up the measurement points.</p>
---	--

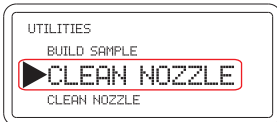
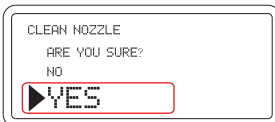
 <p>3 Choose "UTILITIES", and press "OK".</p>	 <p>4 Choose "CLEAN NOZZLE" and press "OK".</p>	 <p>5 Choose "YES" and press "OK".</p>
---	---	---

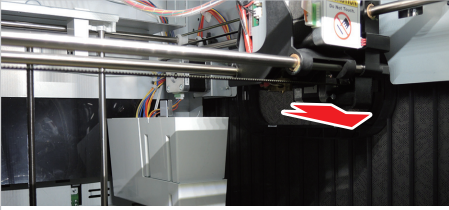
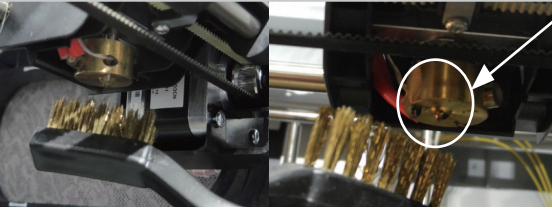
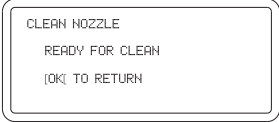
 <p>6 Wait until the extruder heats up and moves to the front.</p>	 <p>7 Clean the surface of the print head using the cooper brush.</p>	 <p>8 Press "OK" when finish cleaning.</p>
--	---	---

B. Clean the heated bed after printing finish

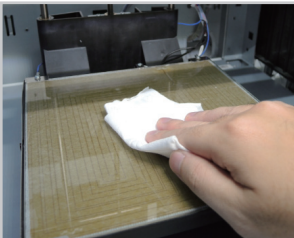
	<ol style="list-style-type: none"> 1 Remove the printed object when the print bed has descended. Cover a damp cloth on the print bed (while cold) for 2~3 minutes. 2 Wipe the moistened glue from the print bed with the damp cloth gently. 3 After cleaning is completed, wipe again with a dry cloth to ensure the print bed is completely dry.
--	--

C. Empty the drip box

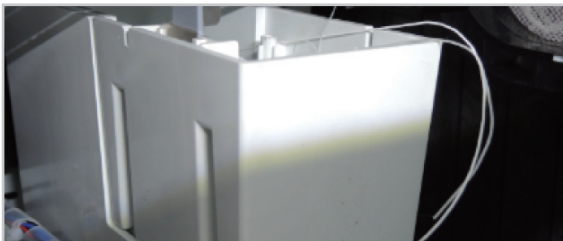

When drip box is full, use "JOG MODE", and choose "Y-AXIS" to move the extruder to the appropriate location.

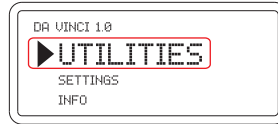

1 Choose "UTILITIES", and press "OK".

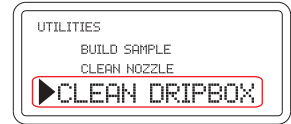

2 Choose "CLEAN DRIPBOX" and press "OK".

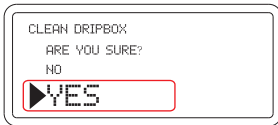

3 Choose "YES" and press "OK" to move the extruder from the dripbox.

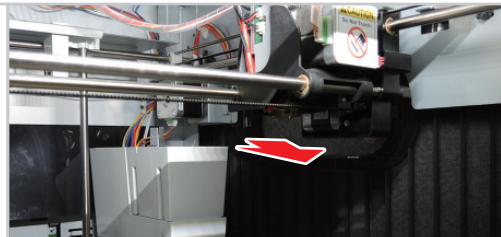

4 Wait until the extruder moves to the center of the chamber.

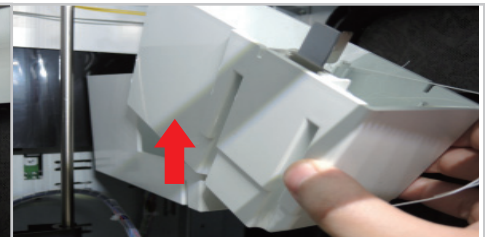

5 Take out the drip box and empty the box.

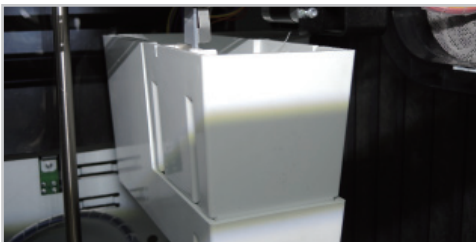

6 When the box is empty, reinstall the dripbox and press OK.

Chapter 8 Term of Service

1. This product is guaranteed for specific period from the purchase date against any breakdown within the scope of proper and reasonable usage of their product as defined by XYZ printing. Presentation of warranty card with the product will ensure free service and repair of inherent faults in the product within the warranty period. However, the following items are separate and dealt with under conditions of other related warranty services:
 - Printing modules / printing platforms / motor modules
 - Attached consumables (including housing, packing materials, power cords, USB cables, coil consumables, user manuals and software CD's): no warranty is given.
2. To protect your right and interests, please request that the dealer fill in the product information and purchase date on the product warranty card, and also make sure that they affix their official seal.
3. Please keep this warranty card in a safe place because if it is lost or destroyed a new one will not be issued. Make sure to present the card if you require any repairs, service or maintenance to the product during the warranty period.
4. XYZprinting may levy charges under any of the following circumstances:
 - Man-made damages: In the case of damage to the product caused by incorrect use, wrong installation, abnormal wear, physical damage or deformation caused by falls or blows, burnt circuits resulting from actions from the user, broken or bent interface or pins or any other physical damage to the product caused by misuse.
 - Incompatibility issues: anything unconnected with product malfunctions such as conflict with electronic equipment, expectation of use, noise of operation, speed, discomfort or heat.
 - Damage caused by force Majeure (such as lightning strike, fire, earthquake, floods, civil disturbance or war or any other event beyond human control).
 - Any request of warranty service after expiration of the warranty period.

If you need warranty service, please contact the original dealer or email us at supportus@xyzprinting.com. If you need more information about our warranty services, please log in to www.xyzprinting.com, select "support (product support)" where you will find complete details of all the warranty conditions.